

Single

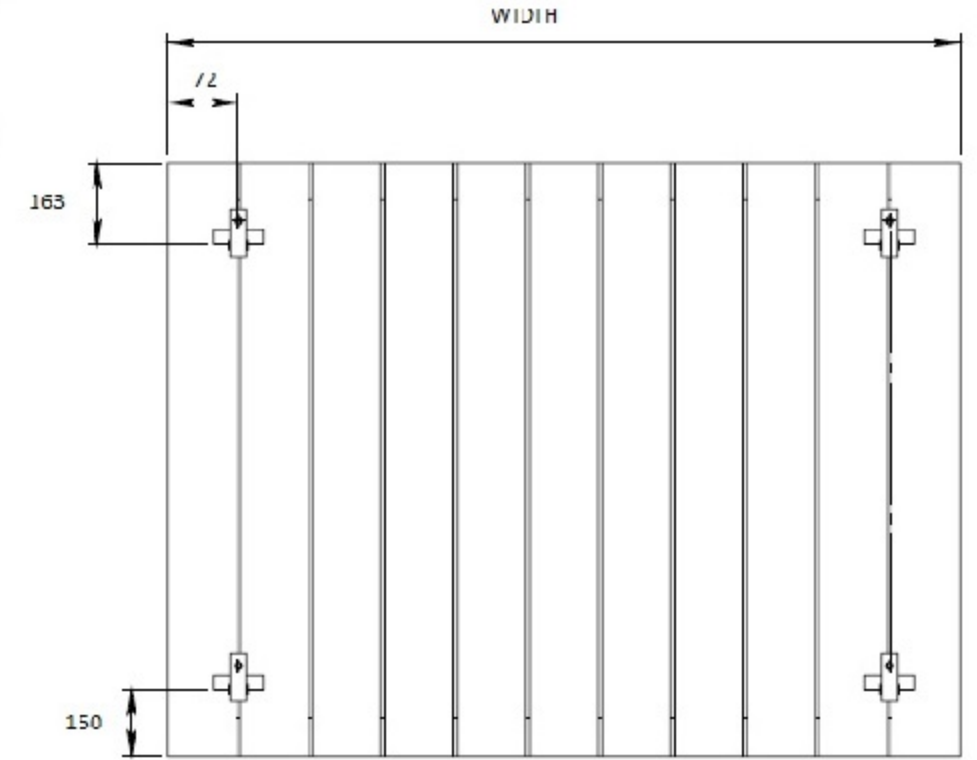

Double

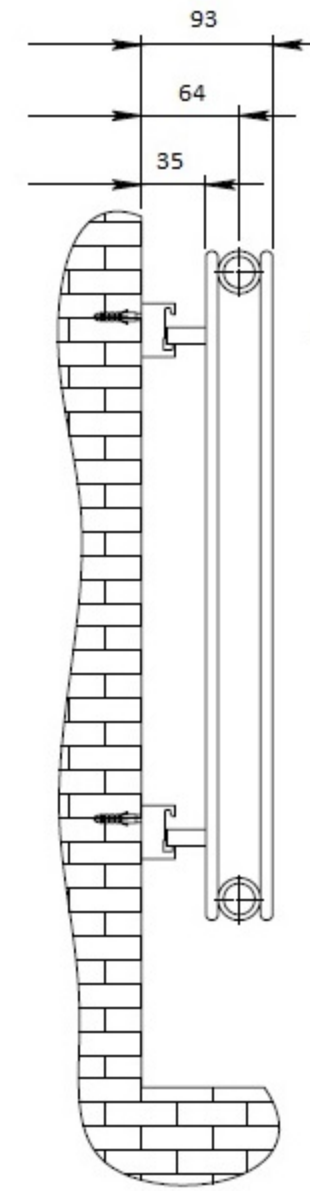
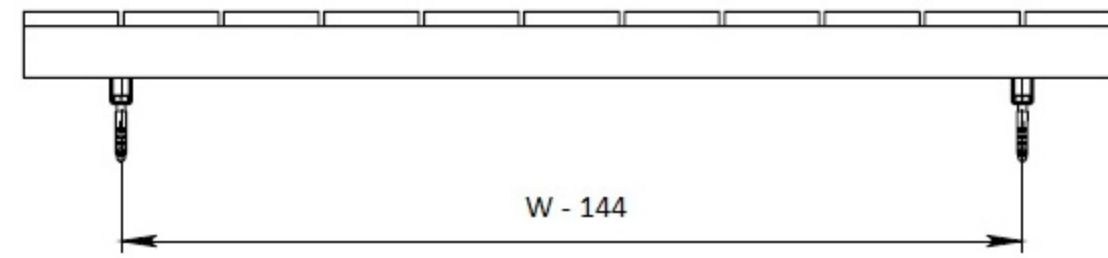
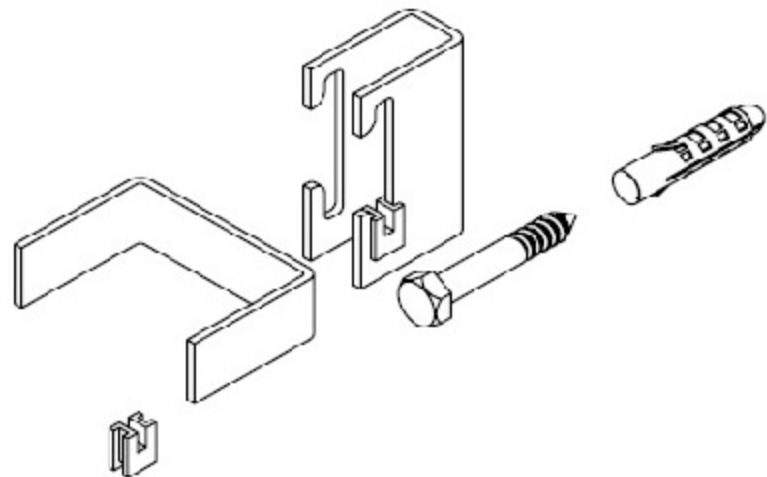
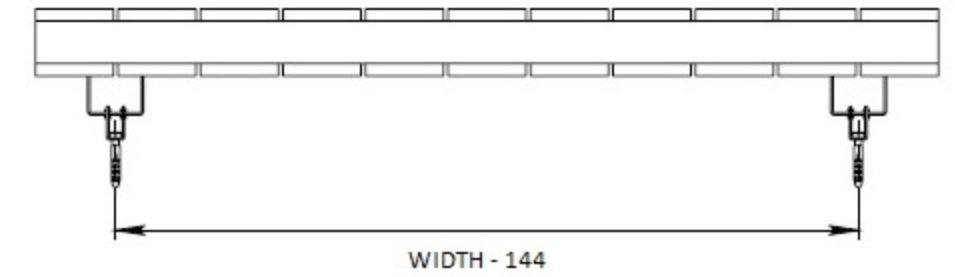

68
39
20
Single

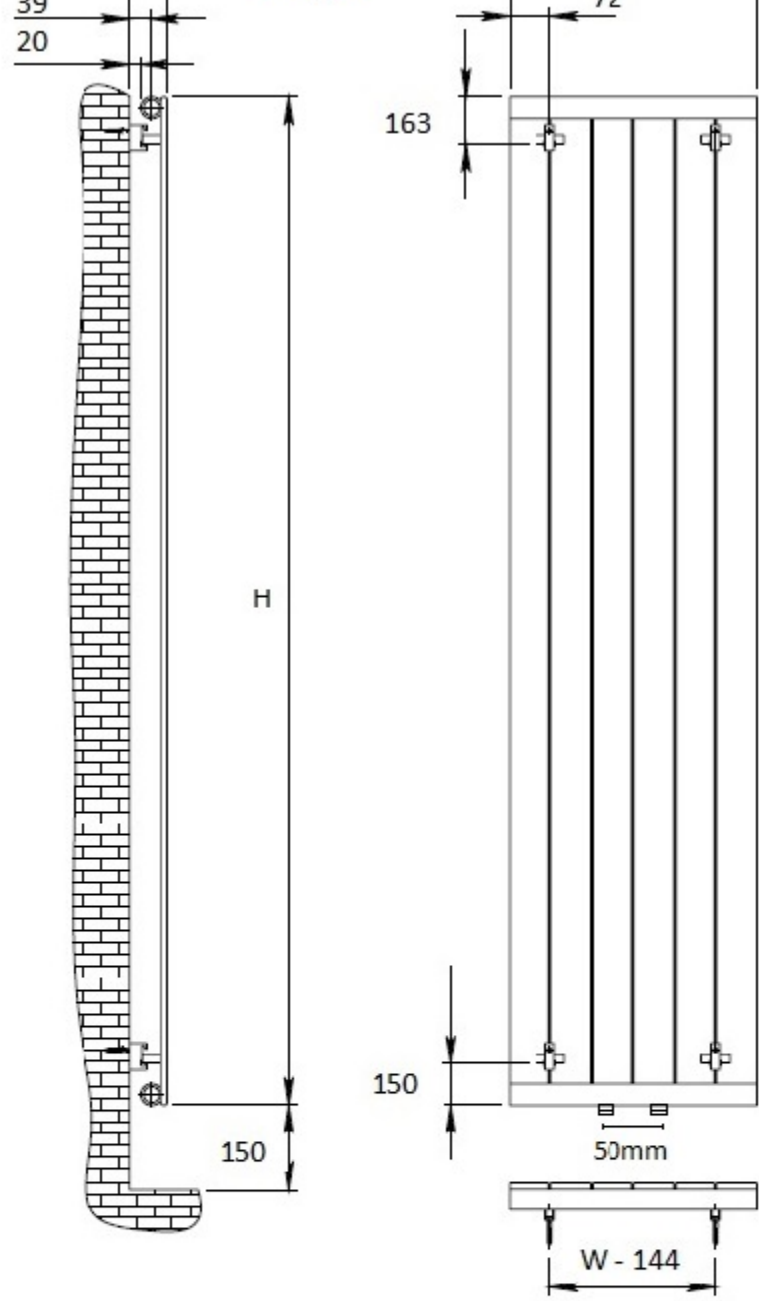

Double

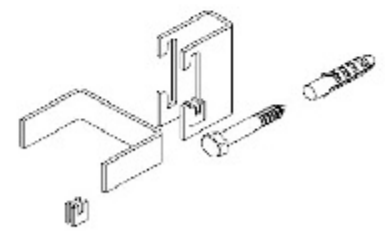
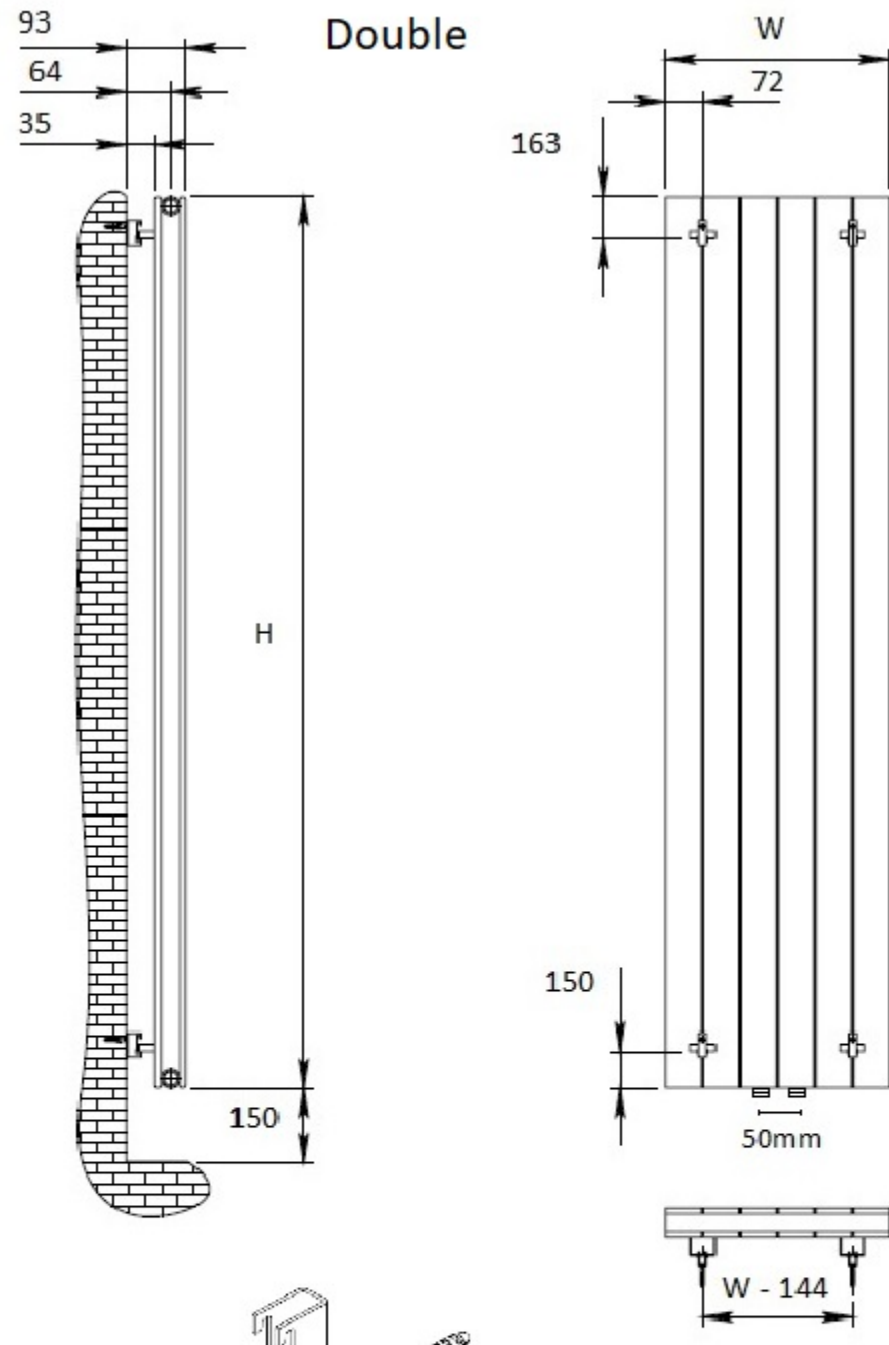

FLAT DESIGN RADIATORS TECHNICAL DETAILS

| PRODUCT CODE | NAMES | Overall Dimension | | Pipe Centres mm | Wall to Pipe centre mm | Wall Distance mm | Tube Quantity | WEIGHT (kg) | WATER CONTENT | Delta T : 50°C watts | Delta T : 30°C watts | m ² radiator kan opvarme |
|------------------------------|-------------------|-------------------|--------|--------------------|---------------------------|---------------------|---------------|-------------|---------------|-------------------------|-------------------------|-------------------------------------|
| | | Height | Length | | | | | | | | | |
| | | mm | mm | | | | | | | | | |
| Vertikal Single White | | | | | | | | | | | | |
| RND-FL122W | FLAT SINGLE WHITE | 1200 | 218 | 50 | 39 | 68 | 3 | 6,3 | 2,2 | 310 | 156 | 2,0 |
| RND-FL123W | FLAT SINGLE WHITE | 1200 | 292 | 50 | 39 | 56 | 4 | 8,4 | 2,9 | 413 | 208 | 3 |
| RND-FL1236W | FLAT SINGLE WHITE | 1200 | 366 | 50 | 39 | 56 | 5 | 10,4 | 3,6 | 516 | 260 | 4 |
| RND-FL1244W | FLAT SINGLE WHITE | 1200 | 440 | 50 | 39 | 56 | 5 | 12,5 | 4,3 | 620 | 312 | 5 |
| RND-FL142W | FLAT SINGLE WHITE | 1400 | 218 | 50 | 39 | 56 | 3 | 7,2 | 2,5 | 354 | 178 | 3 |
| RND-FL143W | FLAT SINGLE WHITE | 1400 | 292 | 50 | 39 | 56 | 4 | 9,6 | 3,3 | 472 | 237 | 4 |
| RND-FL1436W | FLAT SINGLE WHITE | 1400 | 366 | 50 | 39 | 56 | 5 | 12,0 | 4,1 | 590 | 296 | 5 |
| RND-FL163W | FLAT SINGLE WHITE | 1600 | 218 | 50 | 39 | 56 | 3 | 8,2 | 2,8 | 396 | 198 | 6 |
| RND-FL164W | FLAT SINGLE WHITE | 1600 | 292 | 50 | 39 | 56 | 4 | 10,9 | 3,7 | 528 | 264 | 9 |
| RND-FL165W | FLAT SINGLE WHITE | 1600 | 366 | 50 | 39 | 56 | 5 | 13,6 | 4,6 | 660 | 330 | 11 |
| RND-FL166W | FLAT SINGLE WHITE | 1600 | 440 | 50 | 39 | 56 | 6 | 16,3 | 5,5 | 791 | 397 | 13 |
| RND-FL167W | FLAT SINGLE WHITE | 1600 | 514 | 50 | 39 | 56 | 7 | 19,0 | 6,4 | 923 | 463 | 15 |
| RND-FL183W | FLAT SINGLE WHITE | 1800 | 218 | 50 | 39 | 56 | 3 | 9,1 | 3,1 | 436 | 218 | 7 |
| RND-FL184W | FLAT SINGLE WHITE | 1800 | 292 | 50 | 39 | 56 | 4 | 12,1 | 4,1 | 581 | 290 | 10 |
| RND-FL185W | FLAT SINGLE WHITE | 1800 | 366 | 50 | 39 | 56 | 5 | 15,1 | 5,1 | 726 | 363 | 12 |
| RND-FL186W | FLAT SINGLE WHITE | 1800 | 440 | 50 | 39 | 56 | 6 | 18,1 | 6,1 | 872 | 436 | 14 |
| RND-FL187W | FLAT SINGLE WHITE | 1800 | 514 | 50 | 39 | 56 | 7 | 21,1 | 7,1 | 1017 | 508 | 17 |
| Vertikal Double White | | | | | | | | | | | | |
| RND-FL122WD | FLAT DOUBLE WHITE | 1200 | 218 | 50 | 64 | 93 | 6 | 11,9 | 4,0 | 443 | 223 | 5 |
| RND-FL123WD | FLAT DOUBLE WHITE | 1200 | 292 | 50 | 64 | 93 | 8 | 15,9 | 5,3 | 590 | 297 | 7 |
| RND-FL1236WD | FLAT DOUBLE WHITE | 1200 | 366 | 50 | 64 | 93 | 10 | 19,8 | 6,7 | 738 | 372 | 9 |
| RND-FL1244W | FLAT DOUBLE WHITE | 1200 | 440 | 50 | 64 | 93 | 12 | 23,8 | 8,0 | 885 | 446 | 10 |
| RND-FL142W | FLAT DOUBLE WHITE | 1400 | 218 | 50 | 64 | 93 | 6 | 13,8 | 4,6 | 505 | 254 | 6 |
| RND-FL143W | FLAT DOUBLE WHITE | 1400 | 292 | 50 | 64 | 93 | 8 | 18,4 | 6,1 | 674 | 338 | 8 |
| RND-FL1436W | FLAT DOUBLE WHITE | 1400 | 366 | 50 | 64 | 93 | 10 | 22,9 | 7,6 | 842 | 423 | 11 |
| RND-FL163WD | FLAT DOUBLE WHITE | 1600 | 218 | 50 | 64 | 93 | 6 | 15,7 | 5,2 | 565 | 283 | 12 |
| RND-FL164WD | FLAT DOUBLE WHITE | 1600 | 292 | 50 | 64 | 93 | 8 | 20,9 | 6,9 | 754 | 378 | 15 |

| | | | | | | | | | | | | |
|--------------|-------------------|------|-----|----|----|----|----|------|------|------|------|----|
| RND-FL165WD | FLAT DOUBLE WHITE | 1600 | 366 | 50 | 64 | 93 | 10 | 26,0 | 8,6 | 942 | 472 | 19 |
| RND-FL166WD | FLAT DOUBLE WHITE | 1600 | 440 | 50 | 64 | 93 | 12 | 31,2 | 10,4 | 1131 | 566 | 23 |
| RND-FL167WD | FLAT DOUBLE WHITE | 1600 | 514 | 50 | 64 | 93 | 14 | 36,4 | 12,1 | 1319 | 661 | 25 |
| RND-FL183WD | FLAT DOUBLE WHITE | 1800 | 218 | 50 | 64 | 93 | 6 | 17,5 | 5,8 | 623 | 311 | 13 |
| RND-FL184WD | FLAT DOUBLE WHITE | 1800 | 292 | 50 | 64 | 93 | 8 | 23,4 | 7,7 | 830 | 415 | 17 |
| RND-FL185WD | FLAT DOUBLE WHITE | 1800 | 366 | 50 | 64 | 93 | 10 | 29,2 | 9,6 | 1038 | 519 | 22 |
| RND-FL186WD | FLAT DOUBLE WHITE | 1800 | 440 | 50 | 64 | 93 | 12 | 35,0 | 11,6 | 1245 | 622 | 26 |
| RND-FL187WD | FLAT DOUBLE WHITE | 1800 | 514 | 50 | 64 | 93 | 14 | 40,8 | 13,5 | 1453 | 726 | 30 |
| RND-FL207WD | FLAT DOUBLE WHITE | 2000 | 514 | 50 | 64 | 93 | 14 | 45,2 | 14,9 | 1581 | 793 | 32 |
| RND-FL208WD | FLAT DOUBLE WHITE | 2000 | 588 | 50 | 64 | 93 | 16 | 51,6 | 17,0 | 1807 | 907 | 36 |
| RND-FL209WD | FLAT DOUBLE WHITE | 2000 | 662 | 50 | 64 | 93 | 18 | 58,0 | 19,1 | 2032 | 1020 | 41 |
| RND-FL2012WD | FLAT DOUBLE WHITE | 2000 | 810 | 50 | 64 | 93 | 24 | 70,9 | 23,4 | 2484 | 1247 | 50 |

Horizontal Single White

| | | | | | | | | | | | | |
|-----------|-------------------|-----|------|------|----|----|----|------|------|------|-----|----|
| RND-FL06W | FLAT SINGLE WHITE | 600 | 440 | 440 | 39 | 68 | 6 | 6,9 | 2,5 | 331 | 169 | 4 |
| RND-FL08W | FLAT SINGLE WHITE | 600 | 588 | 588 | 39 | 68 | 8 | 9,2 | 3,4 | 442 | 226 | 6 |
| RND-FL11W | FLAT SINGLE WHITE | 600 | 810 | 810 | 39 | 68 | 11 | 12,6 | 4,7 | 608 | 310 | 8 |
| RND-FL13W | FLAT SINGLE WHITE | 600 | 958 | 958 | 39 | 68 | 13 | 14,9 | 5,5 | 718 | 367 | 9 |
| RND-FL14W | FLAT SINGLE WHITE | 600 | 1032 | 1032 | 39 | 68 | 14 | 16,0 | 6,0 | 773 | 395 | 10 |
| RND-FL16W | FLAT SINGLE WHITE | 600 | 1180 | 1180 | 39 | 68 | 16 | 18,3 | 6,8 | 884 | 451 | 10 |
| RND-FL17W | FLAT SINGLE WHITE | 600 | 1254 | 1254 | 39 | 68 | 17 | 19,4 | 7,2 | 939 | 480 | 13 |
| RND-FL19W | FLAT SINGLE WHITE | 600 | 1402 | 1402 | 39 | 68 | 19 | 21,7 | 8,1 | 1050 | 536 | 15 |
| RND-FL23W | FLAT SINGLE WHITE | 600 | 1624 | 1624 | 39 | 68 | 22 | 25,1 | 9,4 | 1215 | 621 | 17 |
| RND-FL26W | FLAT SINGLE WHITE | 600 | 1772 | 1772 | 39 | 68 | 24 | 27,3 | 10,2 | 1326 | 677 | 18 |
| RND-FL29W | FLAT SINGLE WHITE | 600 | 1994 | 1994 | 39 | 68 | 27 | 30,8 | 11,5 | 1492 | 762 | 20 |

Horizontal Double White

| | | | | | | | | | | | | |
|-------------|-------------------|-----|------|------|----|----|----|------|------|------|-----|----|
| RND-FL408WD | FLAT DOUBLE WHITE | 400 | 440 | 440 | 64 | 93 | 12 | 8,8 | 3,2 | 324 | 166 | 5 |
| RND-FL408WD | FLAT DOUBLE WHITE | 400 | 588 | 588 | 64 | 93 | 16 | 11,7 | 4,3 | 432 | 221 | 7 |
| RND-FL411WD | FLAT DOUBLE WHITE | 400 | 810 | 810 | 64 | 93 | 22 | 16,0 | 5,9 | 593 | 305 | 10 |
| RND-FL13WD | FLAT DOUBLE WHITE | 400 | 958 | 958 | 64 | 93 | 26 | 18,9 | 7,0 | 701 | 360 | 12 |
| RND-FL14WD | FLAT DOUBLE WHITE | 400 | 1032 | 1032 | 64 | 93 | 28 | 20,4 | 7,5 | 755 | 388 | 13 |
| RND-FL14WD | FLAT DOUBLE WHITE | 400 | 1180 | 1180 | 64 | 93 | 32 | 23,3 | 8,6 | 863 | 443 | 14 |
| RND-FL17WD | FLAT DOUBLE WHITE | 400 | 1254 | 1254 | 64 | 93 | 34 | 24,7 | 9,2 | 917 | 471 | 15 |
| RND-FL20WD | FLAT DOUBLE WHITE | 400 | 1402 | 1402 | 64 | 93 | 38 | 27,6 | 10,2 | 1025 | 526 | 17 |
| RND-FL23WD | FLAT DOUBLE WHITE | 400 | 1624 | 1624 | 64 | 93 | 44 | 29,0 | 10,8 | 1079 | 554 | 18 |
| RND-FL26WD | FLAT DOUBLE WHITE | 400 | 1772 | 1772 | 64 | 93 | 48 | 31,9 | 11,9 | 1187 | 609 | 20 |
| RND-FL29WD | FLAT DOUBLE WHITE | 400 | 1994 | 1994 | 64 | 93 | 52 | 34,8 | 12,9 | 1295 | 664 | 22 |
| RND-FL32WD | FLAT DOUBLE WHITE | 400 | 2216 | 2216 | 64 | 93 | 60 | 39,2 | 14,5 | 1456 | 747 | 24 |

| | | | | | | | | | | | | |
|------------|-------------------|-----|------|------|----|----|----|------|------|------|------|----|
| RND-FL32WD | FLAT DOUBLE WHITE | 400 | 2364 | 2364 | 64 | 93 | 64 | 46,4 | 17,2 | 1726 | 886 | 29 |
| RND-FL32WD | FLAT DOUBLE WHITE | 400 | 2438 | 2438 | 64 | 93 | 66 | 47,9 | 17,8 | 1780 | 914 | 30 |
| RND-FL32WD | FLAT DOUBLE WHITE | 400 | 2586 | 2586 | 64 | 93 | 70 | 50,8 | 18,9 | 1888 | 969 | 31 |
| RND-FL08WD | FLAT DOUBLE WHITE | 500 | 440 | 440 | 64 | 93 | 16 | 10,6 | 3,8 | 399 | 204 | 7 |
| RND-FL08WD | FLAT DOUBLE WHITE | 500 | 588 | 588 | 64 | 93 | 16 | 14,2 | 5,1 | 533 | 273 | 9 |
| RND-FL11WD | FLAT DOUBLE WHITE | 500 | 810 | 810 | 64 | 93 | 22 | 19,4 | 7,0 | 732 | 375 | 12 |
| RND-FL13WD | FLAT DOUBLE WHITE | 500 | 958 | 958 | 64 | 93 | 26 | 23,0 | 8,3 | 865 | 443 | 14 |
| RND-FL14WD | FLAT DOUBLE WHITE | 500 | 1032 | 1032 | 64 | 93 | 28 | 24,7 | 8,9 | 932 | 477 | 16 |
| RND-FL13WD | FLAT DOUBLE WHITE | 500 | 1180 | 1180 | 64 | 93 | 32 | 28,2 | 10,2 | 1065 | 545 | 18 |
| RND-FL17WD | FLAT DOUBLE WHITE | 500 | 1254 | 1254 | 64 | 93 | 34 | 30,0 | 10,8 | 1132 | 579 | 19 |
| RND-FL20WD | FLAT DOUBLE WHITE | 500 | 1402 | 1402 | 64 | 93 | 38 | 33,5 | 12,1 | 1265 | 648 | 21 |
| RND-FL22WD | FLAT DOUBLE WHITE | 500 | 1624 | 1624 | 64 | 93 | 44 | 38,8 | 14,0 | 1465 | 750 | 24 |
| RND-FL24WD | FLAT DOUBLE WHITE | 500 | 1772 | 1772 | 64 | 93 | 48 | 42,3 | 15,3 | 1598 | 818 | 27 |
| RND-FL27WD | FLAT DOUBLE WHITE | 500 | 1994 | 1994 | 64 | 93 | 52 | 47,6 | 17,2 | 1798 | 920 | 30 |
| RND-FL30WD | FLAT DOUBLE WHITE | 500 | 2216 | 2216 | 64 | 93 | 60 | 52,9 | 19,1 | 1997 | 1022 | 33 |
| RND-FL32WD | FLAT DOUBLE WHITE | 500 | 2364 | 2364 | 64 | 93 | 64 | 56,4 | 20,4 | 2130 | 1091 | 36 |
| RND-FL33WD | FLAT DOUBLE WHITE | 500 | 2438 | 2438 | 64 | 93 | 66 | 58,2 | 21,1 | 2197 | 1125 | 37 |
| RND-FL35WD | FLAT DOUBLE WHITE | 500 | 2586 | 2586 | 64 | 93 | 70 | 61,7 | 22,3 | 2330 | 1193 | 39 |
| RND-FL06WD | FLAT DOUBLE WHITE | 600 | 440 | 440 | 64 | 93 | 12 | 12,5 | 4,4 | 474 | 242 | 8 |
| RND-FL08WD | FLAT DOUBLE WHITE | 600 | 588 | 588 | 64 | 93 | 16 | 16,7 | 5,9 | 631 | 322 | 11 |
| RND-FL11WD | FLAT DOUBLE WHITE | 600 | 810 | 810 | 64 | 93 | 22 | 22,9 | 8,1 | 868 | 443 | 14 |
| RND-FL13WD | FLAT DOUBLE WHITE | 600 | 958 | 958 | 64 | 93 | 26 | 27,0 | 9,6 | 1026 | 524 | 17 |
| RND-FL14WD | FLAT DOUBLE WHITE | 600 | 1032 | 1032 | 64 | 93 | 28 | 29,1 | 10,3 | 1105 | 564 | 18 |
| RND-FL16WD | FLAT DOUBLE WHITE | 600 | 1180 | 1180 | 64 | 93 | 32 | 33,2 | 11,8 | 1263 | 645 | 21 |
| RND-FL17WD | FLAT DOUBLE WHITE | 600 | 1254 | 1254 | 64 | 93 | 34 | 35,3 | 12,5 | 1342 | 685 | 22 |
| RND-FL19WD | FLAT DOUBLE WHITE | 600 | 1402 | 1402 | 64 | 93 | 38 | 39,5 | 14,0 | 1500 | 766 | 25 |
| RND-FL20WD | FLAT DOUBLE WHITE | 600 | 1476 | 1476 | 64 | 93 | 40 | 41,5 | 14,7 | 1579 | 806 | 26 |
| RND-FL22WD | FLAT DOUBLE WHITE | 600 | 1624 | 1624 | 64 | 93 | 44 | 45,7 | 16,2 | 1736 | 887 | 29 |
| RND-FL24WD | FLAT DOUBLE WHITE | 600 | 1772 | 1772 | 64 | 93 | 48 | 49,8 | 17,7 | 1894 | 967 | 32 |
| RND-FL27WD | FLAT DOUBLE WHITE | 600 | 1994 | 1994 | 64 | 93 | 52 | 56,0 | 19,9 | 2131 | 1088 | 36 |
| RND-FL30WD | FLAT DOUBLE WHITE | 600 | 2216 | 2216 | 64 | 93 | 60 | 62,2 | 22,1 | 2368 | 1209 | 39 |

Vertical Single Anthracite

| | | | | | | | | | | | | |
|-------------|------------------------|------|-----|----|----|----|---|------|-----|-----|-----|-----|
| RND-FL122A | FLAT SINGLE ANTHRACITE | 1200 | 218 | 50 | 39 | 68 | 3 | 6,3 | 2,2 | 310 | 156 | 2,6 |
| RND-FL123A | FLAT SINGLE ANTHRACITE | 1200 | 292 | 50 | 39 | 68 | 4 | 8,4 | 2,9 | 413 | 208 | 3 |
| RND-FL1236A | FLAT SINGLE ANTHRACITE | 1200 | 366 | 50 | 39 | 68 | 5 | 10,4 | 3,6 | 516 | 260 | 4 |
| RND-FL142A | FLAT SINGLE ANTHRACITE | 1400 | 218 | 50 | 39 | 68 | 3 | 7,2 | 2,5 | 354 | 178 | 3 |
| RND-FL143A | FLAT SINGLE ANTHRACITE | 1400 | 292 | 50 | 39 | 68 | 4 | 9,6 | 3,3 | 472 | 237 | 4 |

| | | | | | | | | | | | | |
|-------------|------------------------|------|-----|----|----|----|---|------|-----|------|-----|----|
| RND-FL1436A | FLAT SINGLE ANTHRACITE | 1400 | 366 | 50 | 39 | 68 | 5 | 12,0 | 4,1 | 590 | 296 | 5 |
| RND-FL163A | FLAT SINGLE ANTHRACITE | 1600 | 218 | 50 | 39 | 68 | 3 | 8,2 | 2,8 | 396 | 198 | 6 |
| RND-FL164A | FLAT SINGLE ANTHRACITE | 1600 | 292 | 50 | 39 | 68 | 4 | 10,9 | 3,7 | 528 | 264 | 9 |
| RND-FL165A | FLAT SINGLE ANTHRACITE | 1600 | 366 | 50 | 39 | 68 | 5 | 13,6 | 4,6 | 660 | 330 | 11 |
| RND-FL166A | FLAT SINGLE ANTHRACITE | 1600 | 440 | 50 | 39 | 68 | 6 | 16,3 | 5,5 | 791 | 397 | 13 |
| RND-FL167A | FLAT SINGLE ANTHRACITE | 1600 | 514 | 50 | 39 | 68 | 7 | 19,0 | 6,4 | 923 | 463 | 15 |
| RND-FL183A | FLAT SINGLE ANTHRACITE | 1800 | 218 | 50 | 39 | 68 | 3 | 9,1 | 3,1 | 436 | 218 | 7 |
| RND-FL184A | FLAT SINGLE ANTHRACITE | 1800 | 292 | 50 | 39 | 68 | 4 | 12,1 | 4,1 | 581 | 290 | 10 |
| RND-FL185A | FLAT SINGLE ANTHRACITE | 1800 | 366 | 50 | 39 | 68 | 5 | 15,1 | 5,1 | 726 | 363 | 12 |
| RND-FL186A | FLAT SINGLE ANTHRACITE | 1800 | 440 | 50 | 39 | 68 | 6 | 18,1 | 6,1 | 872 | 436 | 14 |
| RND-FL187A | FLAT SINGLE ANTHRACITE | 1800 | 514 | 50 | 39 | 68 | 7 | 21,1 | 7,1 | 1017 | 508 | 17 |

Vertical Double Anthracite

| | | | | | | | | | | | | |
|--------------|------------------------|------|-----|----|----|----|----|------|------|------|-----|----|
| RND-FL122AD | FLAT DOUBLE ANTHRACITE | 1200 | 218 | 50 | 64 | 93 | 6 | 6,3 | 2,2 | 310 | 156 | 5 |
| RND-FL123AD | FLAT DOUBLE ANTHRACITE | 1200 | 292 | 50 | 64 | 93 | 8 | 8,4 | 2,9 | 413 | 208 | 7 |
| RND-FL1236AD | FLAT DOUBLE ANTHRACITE | 1200 | 366 | 50 | 64 | 93 | 10 | 10,4 | 3,6 | 516 | 260 | 9 |
| RND-FL142AD | FLAT DOUBLE ANTHRACITE | 1400 | 218 | 50 | 64 | 93 | 12 | 13,8 | 4,6 | 505 | 254 | 6 |
| RND-FL143AD | FLAT DOUBLE ANTHRACITE | 1400 | 292 | 50 | 64 | 93 | 14 | 18,4 | 6,1 | 674 | 338 | 8 |
| RND-FL1436AD | FLAT DOUBLE ANTHRACITE | 1400 | 366 | 50 | 64 | 93 | 6 | 22,9 | 7,6 | 842 | 423 | 11 |
| RND-FL163AD | FLAT DOUBLE ANTHRACITE | 1600 | 218 | 50 | 64 | 93 | 6 | 15,7 | 5,2 | 565 | 283 | 12 |
| RND-FL164AD | FLAT DOUBLE ANTHRACITE | 1600 | 292 | 50 | 64 | 93 | 8 | 20,9 | 6,9 | 754 | 378 | 15 |
| RND-FL165AD | FLAT DOUBLE ANTHRACITE | 1600 | 366 | 50 | 64 | 93 | 10 | 26,0 | 8,6 | 942 | 472 | 19 |
| RND-FL166AD | FLAT DOUBLE ANTHRACITE | 1600 | 440 | 50 | 64 | 93 | 12 | 31,2 | 10,4 | 1131 | 566 | 23 |
| RND-FL167AD | FLAT DOUBLE ANTHRACITE | 1600 | 514 | 50 | 64 | 93 | 14 | 36,4 | 12,1 | 1319 | 661 | 25 |
| RND-FL183AD | FLAT DOUBLE ANTHRACITE | 1800 | 218 | 50 | 64 | 93 | 6 | 17,5 | 5,8 | 623 | 311 | 13 |
| RND-FL184AD | FLAT DOUBLE ANTHRACITE | 1800 | 292 | 50 | 64 | 93 | 8 | 23,4 | 7,7 | 830 | 415 | 17 |
| RND-FL185AD | FLAT DOUBLE ANTHRACITE | 1800 | 366 | 50 | 64 | 93 | 10 | 29,2 | 9,6 | 1038 | 519 | 22 |
| RND-FL186AD | FLAT DOUBLE ANTHRACITE | 1800 | 440 | 50 | 64 | 93 | 12 | 35,0 | 11,6 | 1245 | 622 | 26 |
| RND-FL187AD | FLAT DOUBLE ANTHRACITE | 1800 | 514 | 50 | 64 | 93 | 14 | 40,8 | 13,5 | 1453 | 726 | 30 |

Horisontal Single Anthracite

| | | | | | | | | | | | | |
|------------|------------------------|-----|------|------|----|----|----|------|-----|------|-----|----|
| RND-FL06A | FLAT SINGLE ANTHRACITE | 600 | 440 | 440 | 39 | 68 | 6 | 6,9 | 2,5 | 331 | 169 | 4 |
| RND-FL08A | FLAT SINGLE ANTHRACITE | 600 | 588 | 588 | 39 | 68 | 8 | 9,2 | 3,4 | 442 | 226 | 6 |
| RND-FL11A | FLAT SINGLE ANTHRACITE | 600 | 810 | 810 | 39 | 68 | 11 | 12,6 | 4,7 | 608 | 310 | 8 |
| RND-FL11A | FLAT SINGLE ANTHRACITE | 600 | 958 | 958 | 39 | 68 | 13 | 14,9 | 5,5 | 718 | 367 | 9 |
| RND-FL14A | FLAT SINGLE ANTHRACITE | 600 | 1032 | 1032 | 39 | 68 | 14 | 16,0 | 6,0 | 773 | 395 | 10 |
| RND-FL16A | FLAT SINGLE ANTHRACITE | 600 | 1180 | 1180 | 39 | 68 | 16 | 18,3 | 6,8 | 884 | 451 | 10 |
| RND-FL17A | FLAT SINGLE ANTHRACITE | 600 | 1254 | 1254 | 39 | 68 | 17 | 19,4 | 7,2 | 939 | 480 | 13 |
| RND-FL120A | FLAT SINGLE ANTHRACITE | 600 | 1402 | 1402 | 39 | 68 | 19 | 21,7 | 8,1 | 1050 | 536 | 15 |

| | | | | | | | | | | | | |
|------------|------------------------|-----|------|------|----|----|----|------|-----|------|-----|----|
| RND-FL123A | FLAT SINGLE ANTHRACITE | 600 | 1624 | 1624 | 39 | 68 | 22 | 25,1 | 9,4 | 1215 | 621 | 17 |
|------------|------------------------|-----|------|------|----|----|----|------|-----|------|-----|----|

Horizontal Double Anthracite

| | | | | | | | | | | | | |
|------------|------------------------|-----|------|------|----|----|----|------|------|------|-----|----|
| RND-FL06AD | FLAT DOUBLE ANTHRACITE | 600 | 440 | 440 | 64 | 93 | 12 | 12,5 | 4,4 | 474 | 242 | 8 |
| RND-FL08AD | FLAT DOUBLE ANTHRACITE | 600 | 588 | 588 | 64 | 93 | 16 | 16,7 | 5,9 | 631 | 322 | 11 |
| RND-FL11AD | FLAT DOUBLE ANTHRACITE | 600 | 810 | 810 | 64 | 93 | 22 | 22,9 | 8,1 | 868 | 443 | 14 |
| RND-FL13AD | FLAT DOUBLE ANTHRACITE | 600 | 958 | 958 | 64 | 93 | 26 | 27,0 | 9,6 | 1026 | 524 | 17 |
| RND-FL14AD | FLAT DOUBLE ANTHRACITE | 600 | 1032 | 1032 | 64 | 93 | 28 | 29,1 | 10,3 | 1105 | 564 | 18 |
| RND-FL16AD | FLAT DOUBLE ANTHRACITE | 600 | 1180 | 1180 | 64 | 93 | 32 | 33,2 | 11,8 | 1263 | 645 | 21 |
| RND-FL17AD | FLAT DOUBLE ANTHRACITE | 600 | 1254 | 1254 | 64 | 93 | 34 | 35,3 | 12,5 | 1342 | 685 | 22 |
| RND-FL20AD | FLAT DOUBLE ANTHRACITE | 600 | 1402 | 1402 | 64 | 93 | 38 | 39,5 | 14,0 | 1500 | 766 | 25 |
| RND-FL22AD | FLAT DOUBLE ANTHRACITE | 600 | 1624 | 1624 | 64 | 93 | 44 | 45,7 | 16,2 | 1736 | 887 | 29 |

Vertical Single Black

| | | | | | | | | | | | | |
|------------|-------------------|------|-----|----|----|----|---|------|-----|------|-----|----|
| RND-FL123B | FLAT SINGLE BLACK | 1200 | 292 | 50 | 39 | 68 | 4 | 8,4 | 2,9 | 413 | 208 | 3 |
| RND-FL143B | FLAT SINGLE BLACK | 1400 | 292 | 50 | 39 | 68 | 4 | 9,6 | 3,3 | 472 | 237 | 4 |
| RND-FL163B | FLAT SINGLE BLACK | 1600 | 218 | 50 | 39 | 68 | 3 | 8,2 | 2,8 | 396 | 198 | 6 |
| RND-FL164B | FLAT SINGLE BLACK | 1600 | 292 | 50 | 39 | 68 | 4 | 10,9 | 3,7 | 528 | 264 | 9 |
| RND-FL165B | FLAT SINGLE BLACK | 1600 | 366 | 50 | 39 | 68 | 5 | 13,6 | 4,6 | 660 | 330 | 11 |
| RND-FL166B | FLAT SINGLE BLACK | 1600 | 440 | 50 | 39 | 68 | 6 | 16,3 | 5,5 | 791 | 397 | 13 |
| RND-FL167B | FLAT SINGLE BLACK | 1600 | 514 | 50 | 39 | 68 | 7 | 19,0 | 6,4 | 923 | 463 | 15 |
| RND-FL183B | FLAT SINGLE BLACK | 1800 | 218 | 50 | 39 | 68 | 3 | 9,1 | 3,1 | 436 | 218 | 7 |
| RND-FL184B | FLAT SINGLE BLACK | 1800 | 292 | 50 | 39 | 68 | 4 | 12,1 | 4,1 | 581 | 290 | 10 |
| RND-FL185B | FLAT SINGLE BLACK | 1800 | 366 | 50 | 39 | 68 | 5 | 15,1 | 5,1 | 726 | 363 | 12 |
| RND-FL186B | FLAT SINGLE BLACK | 1800 | 440 | 50 | 39 | 68 | 6 | 18,1 | 6,1 | 872 | 436 | 14 |
| RND-FL187B | FLAT SINGLE BLACK | 1800 | 514 | 50 | 39 | 68 | 7 | 21,1 | 7,1 | 1017 | 508 | 17 |

Vertical Double Black

| | | | | | | | | | | | | |
|-------------|-------------------|------|-----|----|----|----|----|------|------|------|-----|----|
| RND-FL123BD | FLAT DOUBLE BLACK | 1200 | 292 | 50 | 64 | 93 | 8 | 8,4 | 2,9 | 413 | 208 | 7 |
| RND-FL143BD | FLAT DOUBLE BLACK | 1400 | 292 | 50 | 64 | 93 | 8 | 18,4 | 6,1 | 674 | 338 | 8 |
| RND-FL163BD | FLAT DOUBLE BLACK | 1600 | 218 | 50 | 64 | 93 | 6 | 15,7 | 5,2 | 565 | 283 | 12 |
| RND-FL164BD | FLAT DOUBLE BLACK | 1600 | 292 | 50 | 64 | 93 | 8 | 20,9 | 6,9 | 754 | 378 | 15 |
| RND-FL165BD | FLAT DOUBLE BLACK | 1600 | 366 | 50 | 64 | 93 | 10 | 26,0 | 8,6 | 942 | 472 | 19 |
| RND-FL166BD | FLAT DOUBLE BLACK | 1600 | 440 | 50 | 64 | 93 | 12 | 31,2 | 10,4 | 1131 | 566 | 23 |
| RND-FL167BD | FLAT DOUBLE BLACK | 1600 | 514 | 50 | 64 | 93 | 14 | 36,4 | 12,1 | 1319 | 661 | 25 |
| RND-FL183BD | FLAT DOUBLE BLACK | 1800 | 218 | 50 | 64 | 93 | 6 | 17,5 | 5,8 | 623 | 311 | 13 |
| RND-FL184BD | FLAT DOUBLE BLACK | 1800 | 292 | 50 | 64 | 93 | 8 | 23,4 | 7,7 | 830 | 415 | 17 |
| RND-FL185BD | FLAT DOUBLE BLACK | 1800 | 366 | 50 | 64 | 93 | 10 | 29,2 | 9,6 | 1038 | 519 | 22 |
| RND-FL186BD | FLAT DOUBLE BLACK | 1800 | 440 | 50 | 64 | 93 | 12 | 35,0 | 11,6 | 1245 | 622 | 26 |

| | | | | | | | | | | | | |
|--------------------------------|-------------------|------|------|------|----|----|----|------|------|------|-----|----|
| RND-FL187BD | FLAT DOUBLE BLACK | 1800 | 514 | 50 | 64 | 93 | 14 | 40,8 | 13,5 | 1453 | 726 | 30 |
| Horizontal Single Black | | | | | | | | | | | | |
| RND-FL06B | FLAT SINGLE BLACK | 600 | 440 | 440 | 39 | 68 | 6 | 6,9 | 2,5 | 331 | 169 | 4 |
| RND-FL08B | FLAT SINGLE BLACK | 600 | 588 | 588 | 39 | 68 | 8 | 9,2 | 3,4 | 442 | 226 | 6 |
| RND-FL11B | FLAT SINGLE BLACK | 600 | 810 | 810 | 39 | 68 | 11 | 12,6 | 4,7 | 608 | 310 | 8 |
| RND-FL11B | FLAT SINGLE BLACK | 600 | 958 | 810 | 39 | 68 | 13 | 14,9 | 5,5 | 718 | 367 | 9 |
| RND-FL14B | FLAT SINGLE BLACK | 600 | 1032 | 1032 | 39 | 68 | 14 | 16,0 | 6,0 | 773 | 395 | 10 |
| RND-FL15B | FLAT SINGLE BLACK | 600 | 1196 | 1196 | 39 | 68 | 16 | 18,3 | 6,8 | 884 | 451 | 10 |
| RND-FL17B | FLAT SINGLE BLACK | 600 | 1254 | 1254 | 39 | 68 | 17 | 19,4 | 7,2 | 939 | 480 | 13 |
| RND-FL17B | FLAT SINGLE BLACK | 600 | 1402 | 1254 | 39 | 68 | 19 | 21,7 | 8,1 | 1050 | 536 | 15 |
| RND-FL17B | FLAT SINGLE BLACK | 600 | 1624 | 1254 | 39 | 68 | 22 | 25,1 | 9,4 | 1215 | 621 | 17 |
| Horizontal Double Black | | | | | | | | | | | | |
| RND-FL06BD | FLAT DOUBLE BLACK | 600 | 440 | 440 | 64 | 93 | 12 | 12,5 | 4,4 | 474 | 242 | 8 |
| RND-FL08BD | FLAT DOUBLE BLACK | 600 | 588 | 588 | 64 | 93 | 16 | 16,7 | 5,9 | 631 | 322 | 11 |
| RND-FL11BD | FLAT DOUBLE BLACK | 600 | 810 | 810 | 64 | 93 | 22 | 22,9 | 8,1 | 868 | 443 | 14 |
| RND-FL11BD | FLAT DOUBLE BLACK | 600 | 958 | 958 | 64 | 93 | 26 | 27,0 | 9,6 | 1026 | 524 | 17 |
| RND-FL14BD | FLAT DOUBLE BLACK | 600 | 1032 | 1032 | 64 | 93 | 28 | 29,1 | 10,3 | 1105 | 564 | 18 |
| RND-FL14BD | FLAT DOUBLE BLACK | 600 | 1196 | 1196 | 64 | 93 | 32 | 33,2 | 11,8 | 1263 | 645 | 21 |
| RND-FL17BD | FLAT DOUBLE BLACK | 600 | 1254 | 1254 | 64 | 93 | 34 | 35,3 | 12,5 | 1342 | 685 | 22 |
| RND-FL17BD | FLAT DOUBLE BLACK | 600 | 1402 | 1402 | 64 | 93 | 38 | 39,5 | 14,0 | 1500 | 766 | 25 |
| RND-FL17BD | FLAT DOUBLE BLACK | 600 | 1624 | 1624 | 64 | 93 | 44 | 45,7 | 16,2 | 1736 | 887 | 29 |